UNIT 2: FIRE SAFETY AND UTILITY CONTROLS

In this unit you will learn about:

- **Fire Chemistry:** How fire occurs, classes of fire, and choosing the correct means to extinguish each type of fire.
- **Fire and Utility Hazards:** Potential fire and utility hazards in the home and workplace, and fire prevention strategies.
- **CERT Sizeup:** How to conduct the continual data-gathering and evaluation process at the scene of a disaster or emergency.
- **Fire Sizeup Considerations:** How to evaluate fires, assess firefighting resources, and determine a course of action.
- **Portable Fire Extinguishers:** Types of portable fire extinguishers and how to operate them.
- **Fire Suppression Safety:** How to decide if you should attempt to extinguish a fire; how to approach and extinguish a fire safely.
- **Hazardous Materials:** How to identify potentially dangerous materials in storage, in transit, and in your home.

[This page intentionally left blank]

COMMUNITY EMERGENCY RESPONSE TEAM
UNIT 2: FIRE SAFETY AND UTILITY CONTROLS

INTRODUCTION AND UNIT OVERVIEW

During, and immediately following a severe emergency, the first priorities of professional fire services are life safety and extinguishing *major* fires.

They may be hampered by impassable roads, weather conditions, inadequate water supply, and other inadequate resources.

UNIT OBJECTIVES

At the end of this unit, you should be able to:

- Explain the role that CERTs play in fire safety.
- Identify and reduce potential fire and utility risks in the home and workplace.
- Describe the 9-step CERT sizeup process.
- Conduct a basic sizeup for a fire emergency.
- Explain minimum safety precautions, including:
 - Safety equipment
 - Utility control
 - Buddy system
 - Backup teams
- Identify locations of hazardous materials in the community and the home and reduce the risk from hazardous materials in the home.
- Extinguish small fires using a fire extinguisher.

COMMUNITY EMERGENCY RESPONSE TEAM
UNIT 2: FIRE SAFETY AND UTILITY CONTROLS

INTRODUCTION AND UNIT OVERVIEW (CONTINUED)

UNIT TOPICS

This unit will provide you with the knowledge and skills that you will need to reduce or eliminate fire hazards and extinguish small fires.

The areas that you will learn about include:

- Fire chemistry
- Fire and utility hazards in the home, workplace, and neighborhood
- CERT sizeup
- Fire sizeup considerations
- Firefighting resources
- Fire suppression safety
- Hazardous materials

At the end of the unit, you will have an opportunity to use a portable extinguisher to put out a fire.

ROLE OF CERTs

CERTs play a very important role in fire and utility safety by:

- Extinguishing small fires before they become major fires
 - This unit will provide training on how to use an extinguisher to put out small fires and how to recognize when a fire is too big to handle. As a general rule, if you can't put out a fire in 5 seconds, it is already too big to handle and you should leave the premises immediately.
- Preventing additional fires by removing fuel sources
 - This unit will also describe how to ensure that a fire, once extinguished, is completely extinguished and stays extinguished. This process is called overhaul.

COMMUNITY EMERGENCY RESPONSE TEAM
UNIT 2: FIRE SAFETY AND UTILITY CONTROLS

INTRODUCTION AND OVERVIEW (CONTINUED)

- Shutting off utilities when necessary and safe to do so
 - This unit will review utility shutoff procedures taught in Unit 1.
- Assisting with evacuations where necessary
 - When a fire is beyond the ability of CERTs to extinguish or a utility emergency has occurred, CERT members need to protect lives by evacuating the area and establishing a perimeter.

CERT PRIORITIES

CERTs play a very important role in neighborhood and workplace fire and utility safety. CERT members help in fire- and utility-related emergencies before professional responders arrive. When responding, CERT members should keep in mind the following CERT standards:

- Rescuer safety is always the number one priority. Therefore, CERT members always:
 - Work with a buddy
 - Wear safety equipment (gloves, helmet, goggles, N95 mask, and sturdy shoes or boots)

The CERT goal is to do the greatest good for the greatest number.

FIRE CHEMISTRY

FIRE CHEMISTRY

Fire requires three elements to exist:

- Heat: Heat is required to elevate the temperature of a material to its ignition point.
- Fuel: The fuel for a fire may be a solid, liquid, or gas. The type and quantity of the fuel will determine which method should be used to extinguish the fire.
- Oxygen: Most fires will burn vigorously in any atmosphere of at least 20 % oxygen. Without oxygen, most fuels could be heated until entirely vaporized, yet would not burn.

These three elements, called the *fire triangle*, create a chemical exothermic reaction, which is fire.

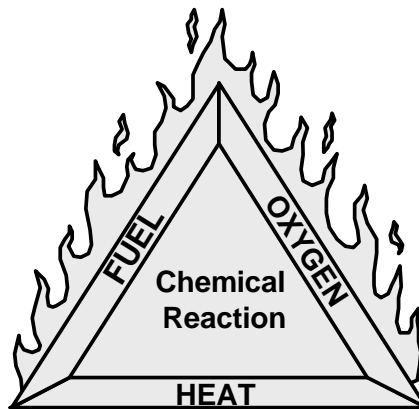

Fire Triangle: Fuel, oxygen, and heat create a chemical reaction, which causes fire.

FIRE CHEMISTRY (CONTINUED)

CLASSES OF FIRE

To aid in extinguishing fires, fires are categorized into classes based on the type of fuel that is burning:

- Class A Fires: Ordinary combustibles such as paper, cloth, wood, rubber, and many plastics
- Class B Fires: Flammable liquids (e.g., oils, gasoline) and combustible liquids (e.g., charcoal lighter fluid, kerosene). These fuels burn only at the surface because oxygen cannot penetrate the depth of the fluid. Only the vapor burns when ignited.
- Class C Fires: Energized electrical equipment (e.g., wiring, motors). When the electricity is turned off, the fire becomes a Class A fire.
- Class D Fires: Combustible metals (e.g., aluminum, magnesium, titanium)
- Class K Fires: Cooking oils (e.g., vegetable oils, animal oils, fats)

It is extremely important to identify the type of fuel feeding the fire in order to select the correct method and agent for extinguishing the fire.

FIRE AND UTILITY HAZARDS

This section will deal with identifying and preventing fire and utility hazards in the home and workplace.

Each of us has some type of fire or utility hazard in our home and workplace. Most of these hazards fall into three categories:

- Electrical hazards
- Natural gas hazards
- Flammable or combustible liquids

Homes and workplaces can and do have other hazards, including incompatible materials stored in close proximity to each other, such as flammables/combustibles, corrosives, compressed gases, and explosives.

Simple fire prevention measures will help reduce the likelihood of fires:

- First, *locate* potential sources of ignition.
- Then, do what you can to *reduce or eliminate* the hazards.

ELECTRICAL HAZARDS

Here are some examples of common electrical hazards and simple ways that they can be reduced or eliminated:

- Avoid the “electrical octopus.” Eliminate tangles of electrical cords. Don’t overload electrical outlets. Don’t plug power strips into other power strips.
- Don’t run electrical cords under carpets.
- Check for and replace broken or frayed cords immediately.
- Maintain electrical appliances properly. Repair or replace malfunctioning appliances.

FIRE AND UTILITY HAZARDS (CONTINUED)

RESPONDING TO ELECTRICAL EMERGENCIES

Electrical emergencies sometimes occur despite our best efforts. Every member of the household should be aware of the following procedures in the event of an electrical emergency:

- Locate the circuit breakers or fuses, and know how to shut off the power. Post shutoff instructions next to the breaker box or fuse box.
- Unscrew individual fuses or switch off smaller breakers first, then pull the main switch or breaker.
- When turning the power back on, turn on the main switch or breaker first, then screw in the fuses or switch on the smaller breakers, one at a time.

You should not enter a flooded basement or standing water to shut off the electrical supply because water conducts electricity.

FIRES AND UTILITY HAZARDS (CONTINUED)

CIRCUIT BOX AND FUSE BOX

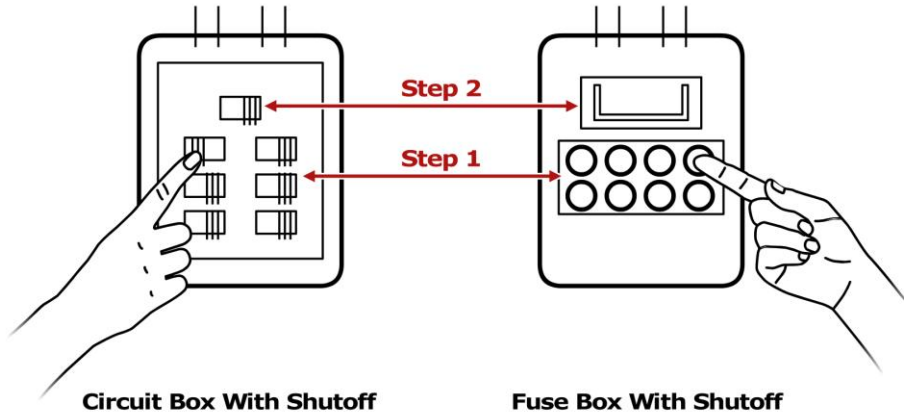

Circuit Box With Shutoff
Circuit box showing shutoff steps.
Step 1: Shut off individual breakers.
Step 2: Shut off main breaker.

Fuse Box With Shutoff
Fuse box showing shutoff steps.
Step 1: Pull out individual fuses.
Step 2: Pull out main fuse.

FIRE AND UTILITY HAZARDS (CONTINUED)

NATURAL GAS HAZARDS

Natural gas presents two types of hazards. It is an:

- Asphyxiant that robs the body of oxygen
- Explosive that can easily ignite

NATURAL GAS HAZARD AWARENESS

Here are several examples for monitoring natural gas in your home:

- As with smoke alarms that need to be strategically placed in your home, e.g., on every level of the home and near all sleeping areas, install a natural gas detector near the furnace, hot water tank, and gas appliances such as clothes dryer or stove. Test the detector monthly to ensure that it works.
- Install a carbon monoxide detector near the sleeping area. Additional detectors may be installed on every level of the home and in every bedroom. Detectors should not be placed within 15 feet of heating or cooking appliances or in or near very humid areas such as bathrooms. Test the detector monthly to ensure that it works.
- Locate and label the gas shutoff valve(s). (There may be multiple valves inside a home in addition to the main shutoff.) Know how to shut off the gas and have the proper non-sparking tool for shutting off the gas.

FIRE AND UTILITY HAZARDS (CONTINUED)

NATURAL GAS METER WITH SHUTOFF

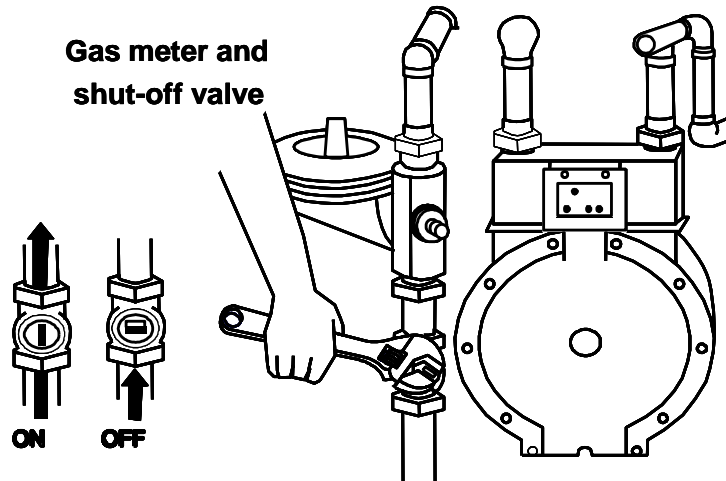

The gas meter shutoff diagram indicates the shutoff valve location on the pipe that comes out of the ground. To turn off the valve, use a non-sparking wrench to turn the valve clockwise one-quarter turn. Remember that, in all cases, natural gas flow should only be turned on by a licensed technician.

Please note: Some gas meters have automatic shutoff valves that restrict the flow of gas during an earthquake or other emergency. These are installed by a licensed plumber, downstream of the utility point of delivery. If you are unsure whether your home has this shutoff device, contact your gas service company. If this shutoff device is closed, only a qualified professional should restore it.

FIRE AND UTILITY HAZARDS (CONTINUED)

GAS SHUTOFF

Gas meter inside the home

If your gas meter is located inside your home, you should only shut off gas flow when instructed to by local authorities. If you smell gas or see the dials on your meter showing gas is flowing even though appliances are turned off, you should evacuate the premises and call 911. Do not attempt to shut off the gas from inside the building if gas may be in the air.

Gas meter outside the home

You should turn off the meter from outside the building if you smell gas or you see dials on the meter showing gas is flowing even though appliances are turned off. If there is a fire that you cannot extinguish, call 911 and turn off the gas only if it is safe to do so.

If you are unsure of the proper procedures, do not attempt to turn the utilities on again yourself, particularly in multiple-unit dwellings. Always follow your local fire department's guidelines. Remember that, in all cases, natural gas that has been shut off can only be restored by a trained technician.

Again, some gas meters have automatic shutoff valves that restrict the flow of gas during an earthquake or other emergency. These are installed by a licensed plumber, downstream of the utility point of delivery. If you are unsure whether your home has this shutoff device, contact your gas service company. If this shutoff device is closed, only a qualified professional should restore it.

Never enter the basement of a structure that is on fire to turn off any utility.

Be sure to use a flashlight, not a candle, if an additional light source is needed to locate and shut off the gas valve.

FLAMMABLE LIQUID HAZARDS

Here are several examples for reducing hazards from flammable liquids:

- Read labels to identify flammable products.
- Store them properly, using the L.I.E.S. method (Limit, Isolate, Eliminate, Separate).

You should only extinguish a flammable liquid using a portable fire extinguisher rated for Class B fires.

COMMUNITY EMERGENCY RESPONSE TEAM
UNIT 2: FIRE SAFETY AND UTILITY CONTROLS

CERT SIZEUP

Sizeup is a continual process that enables professional responders to make decisions and respond appropriately in the areas of greatest need. CERT sizeup consists of 9 steps and should be used in any emergency situation.

CERT SIZEUP STEPS

The 9 steps of CERT sizeup are:

1. Gather facts. What has happened? How many people appear to be involved? What is the current situation?
2. Assess and communicate the damage. Try to determine what has happened, what is happening now, and how bad things can really get.
3. Consider probabilities. What is likely to happen? What could happen through cascading events?
4. Assess your own situation. Are you in immediate danger? Have you been trained to handle the situation? Do you have the equipment that you need?
5. Establish priorities. Are lives at risk? Can you help? Remember, life safety is the first priority!
6. Make decisions. Base your decisions on the answers to Steps 1 through 5 and in accordance with the priorities that you established.
7. Develop a plan of action. Develop a plan that will help you accomplish your priorities. Simple plans may be verbal, but more complex plans should always be written.
8. Take action. Execute your plan, documenting deviations and status changes so that you can report the situation accurately to first responders.
9. Evaluate progress. At intervals, evaluate your progress in accomplishing the objectives in the plan of action to determine what is working and what changes you may have to make to stabilize the situation.

COMMUNITY EMERGENCY RESPONSE TEAM
UNIT 2: FIRE SAFETY AND UTILITY CONTROLS

CERT SIZEUP (CONTINUED)

CERT FIRE SIZEUP

	Yes	No
Step 1: Gather Facts		
<i>Time</i>		
<ul style="list-style-type: none"> ▪ Does the time of day or week affect fire suppression efforts? How? 	<input type="checkbox"/>	<input type="checkbox"/>
<i>Weather</i>		
<ul style="list-style-type: none"> ▪ Are there weather conditions that affect your safety? If yes, how will your safety be affected? 	<input type="checkbox"/>	<input type="checkbox"/>
<ul style="list-style-type: none"> ▪ Will weather conditions affect the fire situation? If yes, how will the fire situation be affected? 	<input type="checkbox"/>	<input type="checkbox"/>
<i>Type of Construction</i>		
<ul style="list-style-type: none"> ▪ What type(s) of structure(s) are involved? 		
<ul style="list-style-type: none"> ▪ What type(s) of construction are involved? 		
<i>Occupancy</i>		
<ul style="list-style-type: none"> ▪ Are the structures occupied? If yes, how many people are likely to be affected? 	<input type="checkbox"/>	<input type="checkbox"/>
<ul style="list-style-type: none"> ▪ Are there special considerations (e.g., children, elderly, pets, people with disabilities)? 	<input type="checkbox"/>	<input type="checkbox"/>

COMMUNITY EMERGENCY RESPONSE TEAM
UNIT 2: FIRE SAFETY AND UTILITY CONTROLS

	Yes	No
<i>Hazards</i>		
<ul style="list-style-type: none"> ▪ Are hazardous materials evident? 	<input type="checkbox"/>	<input type="checkbox"/>
<ul style="list-style-type: none"> ▪ Are any other types of hazards present? If yes, what other hazards? 	<input type="checkbox"/>	<input type="checkbox"/>
Step 2: Assess and Communicate the Damage		
<ul style="list-style-type: none"> ▪ Survey all sides of the building. Is the danger beyond the CERT's capability? 	<input type="checkbox"/>	<input type="checkbox"/>
<ul style="list-style-type: none"> ▪ Have the facts and the initial damage assessment been communicated to the appropriate person(s)? 	<input type="checkbox"/>	<input type="checkbox"/>
Step 3: Consider Probabilities		
<i>Life Hazards</i>		
<ul style="list-style-type: none"> ▪ Are there potentially life-threatening hazards? If yes, what are the hazards? 	<input type="checkbox"/>	<input type="checkbox"/>
<i>Path of Fire</i>		
<ul style="list-style-type: none"> ▪ Does the fire's path jeopardize other areas? If yes, what other areas may be jeopardized? 	<input type="checkbox"/>	<input type="checkbox"/>
<i>Additional Damage</i>		
<ul style="list-style-type: none"> ▪ Is there a high potential for more disaster activity that will impact personal safety? If yes, what are the known risks? 	<input type="checkbox"/>	<input type="checkbox"/>

COMMUNITY EMERGENCY RESPONSE TEAM
UNIT 2: FIRE SAFETY AND UTILITY CONTROLS

	Yes	No
Step 4: Assess Your Own Situation		
<ul style="list-style-type: none"> ▪ What equipment is available to help suppress the fire? 		
<ul style="list-style-type: none"> ▪ What other resources are available? 		
<ul style="list-style-type: none"> ▪ Can fire suppression be <i>safely</i> attempted by CERT members? <u>If not, do <i>not</i> attempt suppression.</u> 	<input type="checkbox"/>	<input type="checkbox"/>
Step 5: Establish Priorities		
<ul style="list-style-type: none"> ▪ Are there other, more pressing needs at the moment? If yes, list. 	<input type="checkbox"/>	<input type="checkbox"/>
Step 6: Make Decisions		
<ul style="list-style-type: none"> ▪ Where will resources do the most good while maintaining an adequate margin of safety? 		
Step 7: Develop a Plan of Action		
<ul style="list-style-type: none"> ▪ Determine how personnel and other resources should be used. 		
Step 8: Take Action		
<ul style="list-style-type: none"> ▪ Put the plan into effect. 		
Step 9: Evaluate Progress		
<ul style="list-style-type: none"> ▪ Continually size up the situation to identify changes in the: <ul style="list-style-type: none"> • Scope of the problem • Safety risks • Resource availability 		
<ul style="list-style-type: none"> ▪ Adjust strategies as required. 		

FIRE SIZEUP CONSIDERATIONS

A sizeup of a situation involving a fire will dictate whether to attempt fire suppression and will help you plan for extinguishing the fire.

CERT sizeup is a continual 9-step process that enables you to make decisions and respond appropriately in the areas of greatest need. Evaluation of progress — Step 9 — may require you to go back and gather more facts.

Remember that the safety of individual CERT members is always the top priority. Effective fire sizeup will allow you to answer all of the following questions:

- Do my buddy and I have the right equipment?
- Are there other hazards?
- Is the building structurally damaged?
- Can my buddy and I escape?
- Can my buddy and I fight the fire safely?

FIREFIGHTING RESOURCES

The most common firefighting resources are:

- Portable fire extinguishers
- Interior wet standpipes

Other resources include confinement and “creative resources.”

FIRE EXTINGUISHERS

Portable fire extinguishers are invaluable for putting out small fires. A well-prepared home or workplace will have at least two portable fire extinguishers of the appropriate type for the location.

Keep in mind that the type of fuel that is burning will determine which resources to select to fight a fire.

Because portable fire extinguishers are most common, this section will focus on them.











TYPES OF FIRE EXTINGUISHERS

There are four types of extinguishers:

- Water
- Dry chemical
- Carbon dioxide
- Specialized fire extinguishers

COMMUNITY EMERGENCY RESPONSE TEAM
UNIT 2: FIRE SAFETY AND UTILITY CONTROLS

Fire Types, Extinguishing Agents, and Methods

FIRE TYPE	EXTINGUISHING AGENT	EXTINGUISHING METHOD
Ordinary Solid Materials  	Water	Removes heat
	Foam	Removes air and heat
	Dry chemical	Breaks chain reaction
Flammable Liquids  	Foam CO ₂	Removes air
	Foam Dry chemical	Breaks chain reaction
Electrical Equipment  	CO ₂	Removes air
	Dry chemical	Breaks chain reaction
Combustible Metals  	Special agents	Usually removes air
Kitchen Oils  	Chemical	Usually removes air

FIREFIGHTING RESOURCES (CONTINUED)

EXTINGUISHER RATING AND LABELING

Portable fire extinguishers must be rated and approved by the State fire marshal and Underwriters Laboratories (an organization that sets safety standards for manufactured goods). They are rated according to their effectiveness on the different classes of fire. Their strength and capability must also be labeled by the manufacturer.

The label contains vital information about the type(s) of fire for which the extinguisher is appropriate.

Extinguishers that are appropriate for Class A fires have a rating from 1A to 40A, with a higher number indicating a higher volume of extinguishing agent.

Extinguishers that are appropriate for Class B fires have a rating from 1B to 640B.

No number accompanies an extinguisher rated Class C, D, or K.

The C on the label indicates only that the extinguisher is safe to use on electrical fires.

Extinguishers for Class D fires must match the type of metal that is burning and are labeled with a list detailing the metals that match the unit's extinguishing agent. These extinguishers also do not use numerical ratings.

Extinguishers for Class K fires are designed to supplement fire suppression systems in commercial kitchens. They spray an alkaline mixture that, when combined with the fatty acid of the burning cooking oil or fat, creates soapy foam to hold in the vapors and extinguish the fire.

COMMUNITY EMERGENCY RESPONSE TEAM
UNIT 2: FIRE SAFETY AND UTILITY CONTROLS

MANUFACTURER'S LABEL ILLUSTRATION

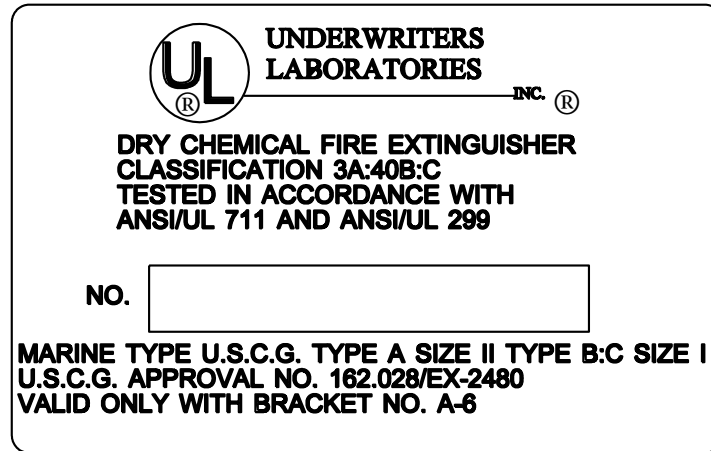

Sample manufacturer's label for a fire extinguisher, showing the Underwriters Laboratories symbol at the top, the type and classification of fire extinguisher, testing procedures used, and serial number. At the bottom of the label is marine information, including the U.S. Coast Guard approval number.

FIREFIGHTING RESOURCES (CONTINUED)

WATER EXTINGUISHERS

Common characteristics of water extinguishers include:

- Capacity. Standard size is 2.5 gallons.
- Range. Standard range is 30-40 feet.
- Pressure. Standard pressure is 110 pounds per square inch (psi).

Use extreme caution when using a water extinguisher to ensure that the water, which is under pressure, does not scatter lightweight materials and spread the fire.

CHEMICAL EXTINGUISHERS

Dry chemical extinguishers are most common.

- Dry chemical extinguishers have a sodium bicarbonate base and are effective on Class B and C fires.
- Multipurpose dry chemical extinguishers have a monoammonium phosphate base and are effective for Class A, B, and C fires.

Common characteristics of dry chemical extinguishers include:

- Capacity. Approximately 10-20 seconds discharge time
- Range. Standard range is 8-12 feet.
- Pressure. Standard pressure is 175-250 psi.

While still in use, carbon dioxide and other specialized extinguishers are becoming less common.

FIREFIGHTING RESOURCES (CONTINUED)

DECIDING TO USE A FIRE EXTINGUISHER

There is a series of questions to ask before attempting to fight a fire with a fire extinguisher:

- Are there two ways to exit the area quickly and safely if I attempt to extinguish the fire? (The first priority for you and your buddy is safety.)
- Do I have the right type of extinguisher for the type of fire?
- Is the extinguisher large enough for the fire?
- Is the area free from other dangers, such as hazardous materials and falling debris?

If you answer “NO” to any of these questions or if you have been unable to put out the fire in 5 seconds using the extinguisher, you should:

- Leave the building immediately.
- Shut all doors as you leave to slow the spread of the fire.

If you answer “YES” to all of these questions, you may attempt to extinguish the fire. Even if you answer “YES” to all of the questions but feel unable to extinguish the fire, you should leave immediately. You should always remember the 5-second rule.

If the fire is extinguished in 5 seconds and the area is safe, you should stay and overhaul the fire. Overhauling is the process of searching a fire scene for hidden fire or sparks in an effort to prevent the fire from rekindling. Remember “cool, soak, and separate.”

COMMUNITY EMERGENCY RESPONSE TEAM
UNIT 2: FIRE SAFETY AND UTILITY CONTROLS

Deciding to Use a Fire Extinguisher

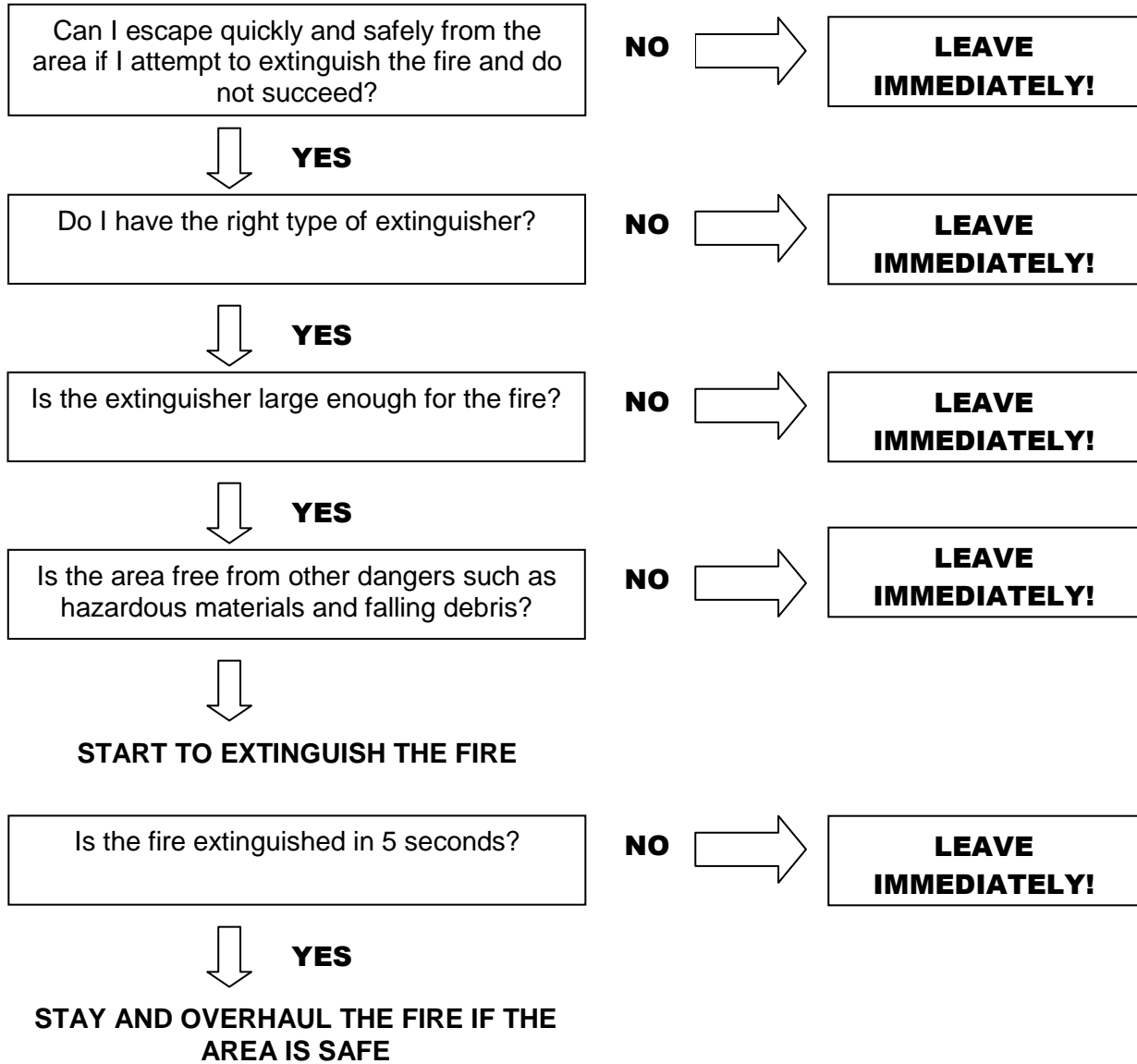

COMMUNITY EMERGENCY RESPONSE TEAM
UNIT 2: FIRE SAFETY AND UTILITY CONTROLS

COMPONENTS OF A PORTABLE FIRE EXTINGUISHER

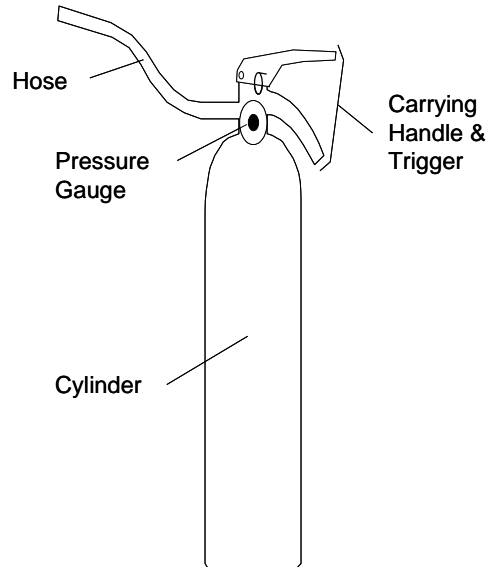

Components of a portable fire extinguisher: Hose, carrying handle and trigger, pressure gauge, cylinder

FIREFIGHTING RESOURCES (CONTINUED)

P.A.S.S.

The acronym for operating a fire extinguisher is P.A.S.S.:

- Pull (Test the extinguisher after pulling the pin)
- Aim
- Squeeze
- Sweep

To ensure that the extinguisher is working properly, test it before approaching any fire.

Be sure to aim at the base of the fire. Any fire extinguishers that have been completely depleted should be laid down and stored on their side so no attempt will be made to use them until they are recharged.

P.A.S.S.

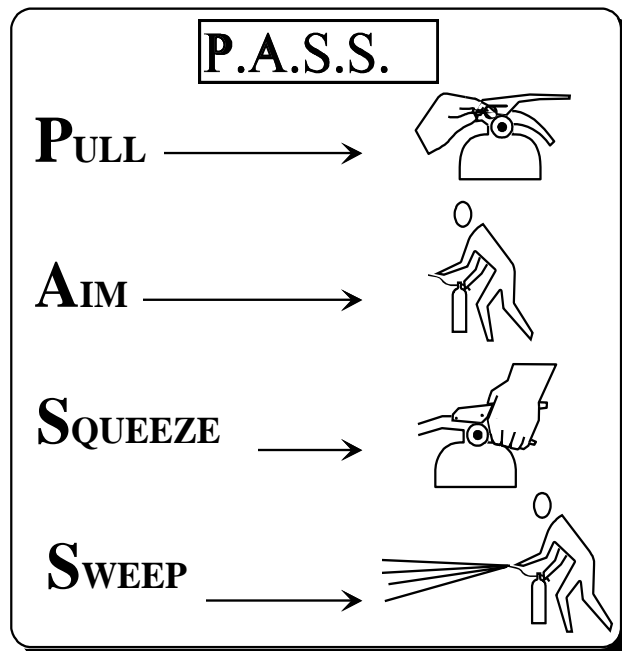

FIREFIGHTING RESOURCES (CONTINUED)

INTERIOR WET STANDPIPES

Interior wet standpipes are usually in commercial and apartment buildings and consist of 100 feet of 1.5-inch jacketed hose with an adjustable spray nozzle. They deliver up to 125 gallons of water per minute.

You will always need to work in two-person teams when using an interior wet standpipe.

Team Member 1: Removes the hose from the cabinet and makes sure that hose is free of kinks and bends in the line. When ready, gives the go-ahead to Team Member 2 to open the water valve.

Team Member 2: After Team Member 1 gives the go-ahead, opens the water valve. Team Member 2 will then backup Team Member 1 at the nozzle.

Due to the dryness of the hose fabric, water may seep through the hose fabric until the hose is saturated. This may last for approximately 1 minute.

CONFINEMENT

In interior spaces, it is possible to *confine* a fire and restrict the spread of smoke and heat by closing doors, interior and exterior.

COMMUNITY EMERGENCY RESPONSE TEAM
UNIT 2: FIRE SAFETY AND UTILITY CONTROLS

FIRE SUPPRESSION SAFETY

As a CERT member, small fire suppression may be one of your roles. Your personal safety must always be your number one concern. You will be unable to help anyone if you are injured through careless sizeup or unsafe acts.

FIRE SUPPRESSION SAFETY RULES

- Use safety equipment at all times. Wear your helmet, goggles, dust mask, leather gloves, and sturdy shoes or boots. If you are not equipped to protect your personal safety, leave the building.
- Work with a buddy. Buddies serve an important purpose. They protect your safety. Don't ever try to fight a fire alone.
- Have a backup team, whenever possible. A backup team just makes good sense. A backup team can support your fire suppression efforts and can provide help if you need it.
- Always have two ways to exit the fire area. Fires spread much faster than you might think. Always have a backup escape plan in case your main escape route becomes blocked.
- Look at the door. If air is being sucked under the door or smoke is coming out the top of the door, do not touch the door.
- Feel closed doors with the back of the hand, working from the bottom of the door up. Do not touch the door handle before feeling the door. If the door is hot, there is fire behind it. Do not enter! Opening the door will feed additional oxygen to the fire.
- Confine the fire, whenever possible, by closing doors and keeping them closed.
- Stay low to the ground. Smoke will naturally rise. Keeping low to the ground will provide you with fresher air to breathe.
- Maintain a safe distance. Remember the effective range of your fire extinguisher. Don't get closer than necessary to extinguish the fire.
- Never turn your back on a fire when backing out.
- Overhaul the fire to be sure that it is extinguished — and stays extinguished.

COMMUNITY EMERGENCY RESPONSE TEAM
UNIT 2: FIRE SAFETY AND UTILITY CONTROLS

FIRE SUPPRESSION SAFETY (CONTINUED)

Sometimes, what CERTs don't do when suppressing fires is as important as what they should do. DON'T:

- Get too close. Stay near the outer range of your extinguisher. If you feel the heat, you are too close.
- Try to fight a fire alone. Remember that your first priority is your personal safety. Don't put it at risk.
- Try to suppress large fires. Learn the capability of your equipment, and do not try to suppress a fire that is clearly too large for the equipment at hand (i.e., a fire that is larger than the combined ratings of available fire extinguishers).
- Enter smoke-filled areas. Suppressing fires in smoke-filled areas requires equipment that CERTs don't have.

COMMUNITY EMERGENCY RESPONSE TEAM
UNIT 2: FIRE SAFETY AND UTILITY CONTROLS

FIRE SUPPRESSION SAFETY (CONTINUED)

PROPER FIRE SUPPRESSION PROCEDURES

A buddy system is used in all cases.

- The job of Team Member 1 is to put out a fire with an extinguisher.
- The job of Team Member 2 is to watch for hazards and ensure the safety of both team members.

Here is the proper fire suppression procedure:

1. Assume ready position. With the pin pulled, Team Member 1 holds the extinguisher aimed and upright, approximately 20 to 25 feet from the fire for small fires.
2. When ready to approach the fire, Team Member 1 should say, "Ready." Team Member 2 should repeat, "Ready."
3. As Team Member 1 begins to move forward, he or she should say, "Going in." Team Member 2 should repeat the command and stay within reach of Team Member 1.
4. Both team members should walk toward the fire. Team Member 1 should watch the fire and Team Member 2 should stay close to Team Member 1, keeping his or her hand on Team Member 1's shoulder. Team Member 2's job is to protect Team Member 1.
5. When Team Member 1 is exiting the fire area, he or she should say, "Backing out." Team Member 2 should repeat the command.
6. Team Member 2 should guide Team Member 1 from the area with his or her hands as Team Member 1 continues facing the fire and looking for other hazards. Team Member 1 must never turn his or her back on the fire scene.

HAZARDOUS MATERIALS

Materials are considered hazardous if they have any of these characteristics:

- Corrode other materials
- Explode or are easily ignited
- React strongly with water
- Are unstable when exposed to heat or shock
- Are otherwise toxic to humans, animals, or the environment through absorption, inhalation, injection, or ingestion

Hazardous materials include, but are not limited to:

- Explosives
- Flammable gases and liquids
- Poisons and poisonous gases
- Corrosives
- Nonflammable gases
- Oxidizers
- Radioactive materials

HAZARDOUS MATERIALS (CONTINUED)

IDENTIFYING HAZARDOUS MATERIALS LOCATIONS

There are several ways to identify locations where hazardous materials are stored, used, or in transit.

- Location and type of occupancy
- Placards
- Sights, sounds, and smells

Location and Type of Occupancy

Hazardous materials are commonplace throughout every community. They are used in many commercial processes and sold in many retail outlets. While these hazards are managed under normal circumstances, accidents and disasters can cause these materials to be released into the environment. Common locations in the community can include:

- Industrial locations (e.g., warehouse, rail yard, shipyard)
- Dry cleaner
- Funeral home
- Home supply store
- Big box store
- Delivery van (UPS, FedEx)

HAZARDOUS MATERIALS (CONTINUED)

Placards

The National Fire Protection Association (NFPA) 704 Diamond is a concise system for identifying the hazards associated with specific materials. The NFPA 704 Diamond placard is found on fixed facilities where hazardous materials are used or stored.

The diamond is divided into four colored quadrants, each with a rating number inside of it, which indicates the degree of risk associated with the material. Numbers range from 1 to 4. **The higher the number the higher the risk!**

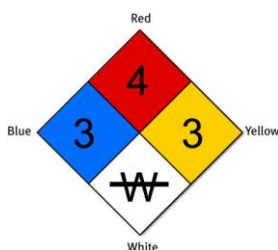

- The red quadrant describes the material's flammability.
- The blue quadrant indicates health hazard.
- The yellow quadrant indicates reactivity.
- The white quadrant indicates special precautions.

There are two symbols specified in the National Fire Codes, section 704.

- W indicates a material that displays unusual reactivity with water (i.e., should never be mixed with water or have water sprayed on it). Magnesium metal is an example of a material that is reactive to water.

OX indicates a material that possesses oxidizing properties. Ammonium nitrate is an example of a material with oxidizing properties. Materials that are oxidizers increase the potential for explosion or fire.

HAZARDOUS MATERIALS (CONTINUED)

In addition to the above symbols that are specified under the National Fire Codes, some NFPA 704 Diamonds will include additional symbols:

- ACID indicates that the material is an acid.
- ALK indicates that the material is a base.
- COR indicates that the material is corrosive.
-  indicates that the material is radioactive.

The numbers within the NFPA 704 Diamond are used to assist professional firefighters in responding to accidents or fires .

CERT members should consider these placards a “stop sign.” The only action CERT members should take is to evacuate persons who are downwind, as necessary, to an uphill or upwind location. Do not enter the building in an attempt to evacuate persons inside.

IDENTIFYING HAZARDOUS MATERIALS IN TRANSIT

There are three ways that hazardous materials are marked and identified while in transit:

- The Department of Transportation (DOT) placard
- The United Nations (UN) system
- The North American (NA) warning placards

These placards can be on any vehicle, not only tankers. Keep in mind that:

- No placard is required for less than 1,000 pounds of many hazardous materials.
- Certain hazardous materials (e.g., anhydrous ammonia) are placarded as a nonflammable gas for domestic transport but as a flammable gas for international transport. (Anhydrous ammonia is a flammable gas!)

Sometimes drivers forget to change the placard when they change their cargo. CERT members should use extreme caution when approaching any vehicle in an accident.

COMMUNITY EMERGENCY RESPONSE TEAM
UNIT 2: FIRE SAFETY AND UTILITY CONTROLS

HAZARDOUS MATERIALS (CONTINUED)

Like the NFPA 704 Diamond, the DOT, UN, and NA placards should be a “stop sign” for CERT members. You should always err on the side of safety. You should *not* assume that, because there is no placard, no hazardous materials are present. Treat any unknown situation as a hazardous materials incident.

DOT PLACARD WARNING



COMMUNITY EMERGENCY RESPONSE TEAM
UNIT 2: FIRE SAFETY AND UTILITY CONTROLS

HAZARDOUS MATERIALS (CONTINUED)

Sights, Sounds, and Smells

Hazardous materials are all around us and may be present regardless of the location or whether there are placards or other posted warnings. While hazardous materials often smell, sound, or look unusual, you may not be able recognize something toxic. You should stay away from any unidentifiable substance and alert building managers or authorities.

COMMUNITY EMERGENCY RESPONSE TEAM
UNIT 2: FIRE SAFETY AND UTILITY CONTROLS

EXERCISE: SUPPRESSING SMALL FIRES
--

Purpose: This exercise will provide you with experience in two key areas of fire suppression:

- Using a portable fire extinguisher to suppress a small fire
- Applying teamwork to fire suppression

Instructions:

1. Identify possible exit routes, wind direction, and whether the fire is spreading.
2. When ready to approach the fire, Team Member 1 should say, "Ready." Team Member 2 should repeat, "Ready." As Team Member 1 begins to move forward, he or she should say, "Going in." Team Member 2 should repeat the command and place his or her hand on Team Member 1's shoulder and stay within reach of Team Member 1.
3. Both team members should walk toward the fire. Team Member 1 should watch the fire and Team Member 2 should stay close to Team Member 1, keeping his or her hand on Team Member 1's shoulder. Team Member 2's job is to protect Team Member 1.
4. Team Member 1 should approach the fire from the windward side (i.e., with the wind to the team member's back). When approximately 10 feet from the fire, Team Member 1 should begin to discharge the extinguisher at the base of the fire, continuing the approach until the range for the extinguisher is optimal.
5. Team Member 1 should sweep the base of the fire until it is extinguished.
6. When Team Member 1 is ready to exit the fire area, he or she should say, "Backing out." Team Member 2 should repeat the command. Team Member 2 should guide Team Member 1 from the area with his or her hands as Team Member 1 continues facing the fire and looking for other hazards.

COMMUNITY EMERGENCY RESPONSE TEAM
UNIT 2: FIRE SAFETY AND UTILITY CONTROLS

UNIT SUMMARY

Effective fire suppression depends on an understanding of:

- The elements required for fire to exist
- The type of fuel involved
- The class of fire
- The resources required and available to extinguish each type of fire
- Effective fire suppression techniques

Fire requires heat, fuel, and oxygen to exist.

There are five types, or classes, of fire:

- Class A: Ordinary combustibles
- Class B: Flammable liquids
- Class C: Energized electrical equipment
- Class D: Combustible metals
- Class K: Cooking oils in commercial kitchens and cafeterias

It is extremely important to identify the class of fire to use the proper extinguisher for the class.

Portable fire extinguishers are most frequently used for suppressing small fires. Their labels tell the types of fires for which they are effective and the area that they can suppress.

When using portable fire extinguishers, remember P.A.S.S.: Pull, Aim, Squeeze, and Sweep. Always test the extinguisher after pulling the pin.

When suppressing a fire, always follow the safety rules established for CERTs.

To help understand the types of materials, there are several methods of placarding hazardous materials being stored or transported, including NFPA, DOT, UN, and NA. When faced with accidents involving materials that are placarded as hazardous — or when the material is unknown — keep away and call for professional help immediately.

COMMUNITY EMERGENCY RESPONSE TEAM
UNIT 2: FIRE SAFETY AND UTILITY CONTROLS

HOMEWORK ASSIGNMENT

Before the next session, you should:

- Read and familiarize yourself with Unit 3: Disaster Medical Operations — Part I in the Participant Manual.
- Obtain and bring to the session:
 - One box of 4- by 4-inch bandages
 - One roll of gauze
 - One medical mask (N95)
 - One pair of examination gloves
 - One blanket

Be sure to wear comfortable clothes for the next session because you will be practicing medical techniques.